

TAKSTAR® 得胜



XR-1016FX / XR-1824FX 模拟调音台 | ANALOG MIXER

使用手册 | USER MANUAL

■ 前言

尊敬的用户：

感谢您选购得胜XR-1016FX/XR-1824FX模拟调音台，为了您能够更好的了解使用本产品，建议您在使用前仔细阅读本说明书。

若存在有疑问或者您有宝贵的建议，可通过拨打得胜官方服务热线4006828333或微信扫描二维码关注得胜官方公众号与我们联系。



■ 产品特性

- 坚固金属外壳
- 专业DSP效果器16种效果可选
- 8/16路XLR麦克风输入，4路总线输出，6路通道内置压缩器；每个通道具有独立的立体声声像控制
- 两个立体声声道具有直接路由到L/R的分配能力
- 带蓝牙模块、USB-A MP3播放，立体声USB-B音频输入输出
- 低噪音的前置放大器及+48V幻象电源
- 每通道带有3段均衡器，可对高、中、低音进行调节
- 录音棚品质耳机输出
- 60毫米高精度推子

■ 适用范围

商业演出，大型集会，户外

■ 包装清单

调音台.....	1台
说明书.....	1份
电源线.....	1条

■ 技术参数

单声道输入通道

麦克风输入: 8/16路平衡XLR
频率响应: 20 Hz - 20 kHz, +/- 1 dB
失真度 (THD+N): <0.003% at +0 dB, 20 Hz-20 kHz
灵敏度: 0 dB to -50 dB
最大输入电平: +20 dBu
麦克风输入阻抗: 14k Ω 非平衡
幻像电源: +48 V
低切频率: 80 Hz

线路输入: 8/16路TRS平衡
频率响应: 20 Hz - 20 kHz, +/- 1dB
失真度 (THD+N): <0.003% at +0 dB, 20 Hz-20 kHz
灵敏度: 20 dB to -30 dB
最大输入电平: +40 dBu
线路输入阻抗: 21 k Ω 非平衡

立体声输入通道

线路输入: 4 对 TRS平衡和2 对 RCA非平衡
频率响应: 20 Hz - 20 kHz, +/- 1 dB
失真度 (THD+N): <0.003% at +0 dB, 20 Hz-20 kHz
灵敏度: 20 dB to -30 dB
线路输入阻抗: 15 k Ω 非平衡

单声道通道EQ

高频: +/-15 dB @ 10 kHz Shelving
中频: +/-15 dB @ Freq.sel. from 100Hz to 8kHz
-Bell
低频: +/-15 dB @ 100 Hz Shelving

数字效果器部份

DSP 处理: 20/27 bit digital signal
A/D 和 D/A 转换器: 24 bit
效果类型: 4 algorithms: reverb, chorus, delay,
flanger - 16 presets
脚踏开关: TS jack (for effect return mute and
unmute)

立体声通道 EQ

高频: +/-15 dB @ 10 kHz Shelving
中频: +/-15 dB @ 1,250 kHz Bell
低频: +/-15 dB @ 100 Hz Shelving

输出部分

主通道输出: 1 对XLR和1 对6.3mm TRS
主通道最大输出电平: +28 dBu
辅助通道输出: 4个 TRS
辅助通道最大输出电平: +28 dBu
立体声编组1,2输出: 2 个TRS
编组输出最大电平: +28 dBu
立体声编组3,4输出: 2 个TRS
编组输出最大电平: +28 dBu
监听输出: 1 对TRS
立体声耳机输出: 1 个立体声TRS

电源供应部分

主输入电压: 100 V - 240 V AC, 50-60 Hz
功耗: 30 W

XR-1016FX 产品尺寸: 468*440*95mm
XR-1824FX 产品尺寸: 680*450*95mm

重量: 6.6Kg
重量: 9.3Kg

■ 使用说明

XR-1016FX背板介绍

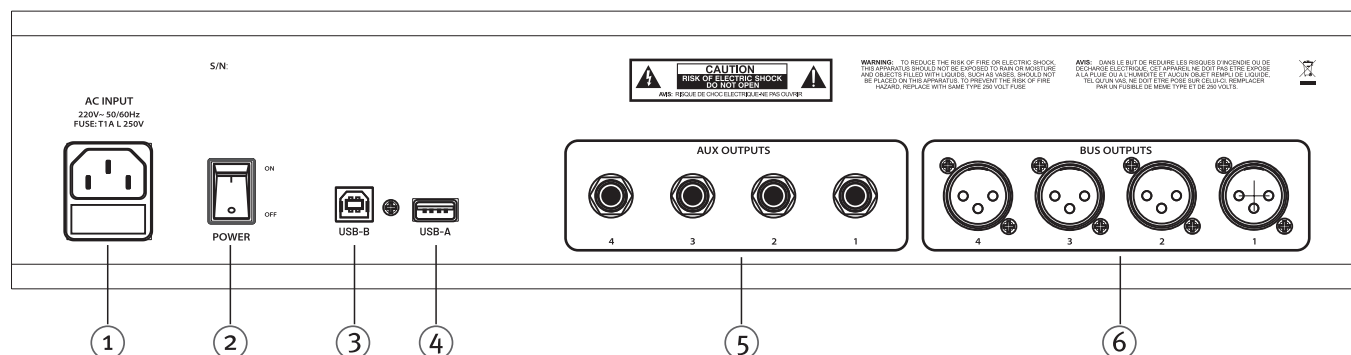

XR-1824FX背板介绍

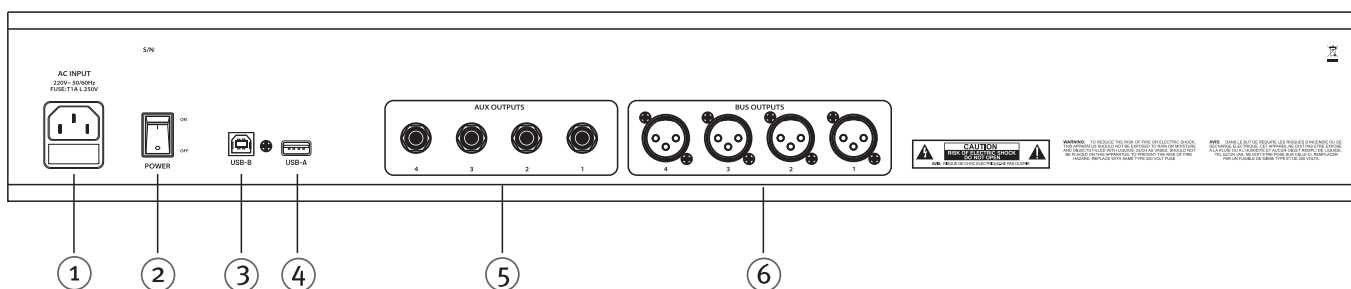

- ① 电源插座
将电源线连接到此插座并正确连接到220V接地交流电源。
- ② 电源开关
打开或关闭调音台电源。
- ③ USB-B计算机连接器
电脑通过USB线连接此端口可进行立体声录音和音频信号的播放。
- ④ USB-A存储连接器
此端口连接U盘使用，可进行播放音乐和录音。
- ⑤ AUX 1 - 4 输出
这些AUX输出具有1/4英寸TRS平衡插孔，并提供来自辅助输出的信号。输出电平由AUX Level控件(10)调节。
- ⑥ BUS1-4输出
这些组输出具有1/4" TRS平衡插孔，并提供来自编组输出的信号。输出电平由组电平推子调节。

单声道输入通道

- ① MIC IN 麦克风输入
XLR平衡麦克风前置放大电路输入支持增益范围为0 dB 至 -50 dB 的音源。所有MIC/LINE输入均配有80 Hz 高通滤波器。使用语音麦克风时启用80 Hz 高通滤波器以减少低频爆音、碰撞和隆隆声。
- ② LINE IN(1/4)线路输入
这些插孔为1/4"平衡 (TRS) 高阻抗输入。芯为正极输入，应用于非平衡输入。话筒和线路输入不应该同时使用。
- ③ GAIN 增益旋钮
增益旋钮它有两个不同的指示，一个代表MIC增益，另一个代表LINE增益，当使用麦克风输入时，增益范围为0-50dB；当你使用LINE输入时，增益范围为-20—+30dB；最佳操作是你将增益控制旋钮置于PEAK灯偶尔闪烁处以避免输入通道失真。
- ④ LOW CUT
低切滤波器从关闭到80Hz 间切换。启用时，它可以通过消除使混音听起来浑浊的低频来提高清晰度。此滤波器可减少操作和舞台噪音、空气噪音和不需要的低频能量，这些低频能量会剥夺您的音响系统的功率。打开此控件将从系统中移除这些频率并在需要时恢复供电。
- ⑤ COMP
顺时针调节此旋钮可降低压缩器的阈值，从而增加压缩量。压缩比在4:1 范围内，随信号电平和压缩量而变化。这对于控制来自现场源的峰值电平很有用，并且旨在巧妙地驯服现场人声的电平，而不会出现明显的伪影。
- ⑥ HIGH EQ
这个缓倾式音调控制调节高音频率电平(10 kHz时±15dB)，降低噪音或增强亮度。
- ⑦ MID EQ
中频控制设置为1250 Hz,增益为+/-15 dB 和钟形曲线。
- ⑧ MID FREQ
这个控制旋钮决定Mid EQ控制的中心频率。带通滤波器的中心频率可以设置在100 Hz至8kHz之间。
- ⑨ LOW EQ
这种缓倾式音调控制调节低音频率电平(100 Hz时为±15 dB),为单薄声音增加深度或为过厚实的声音增加清晰度。
- ⑩ AUX1-4
XR-1016FX混音器的每个通道提供4个辅助发送；AUX1 和AUX2 是PRE 推子发送。AUX3 是POST 或PRE 推子发送，具体取决于AUX3 PRE/POST 按钮 ([32]) 的位置。FX/AUX4 发送总是在推子后。FX/AUX4 发送给内部PRO DSP FX 板。FX/AUX4 发送中的信号也被路由到后面板上的AUX4 OUTPUT 插孔。
- ⑪ PAN
这一控制确定指定的左/右通道及编组1/2总线的信号位置。逆时针旋转控制钮增加发送至左通道及奇数组的信号量；而顺时针旋转则会增加发送至右通道和偶数组的信号量。例如，通道总线分配开关(17)位于1/2位置时，逆时针旋转该钮会增加发送至编组1的信号量，顺时针旋转则增加对编组2的发送量。而中间位发送给各编组的量相等。
- ⑫ MUTE SWITCH
按下这个开关将静音发送到主混音、辅助发送、效果的信号。静音开关不会影响发送到solo系统的信号。

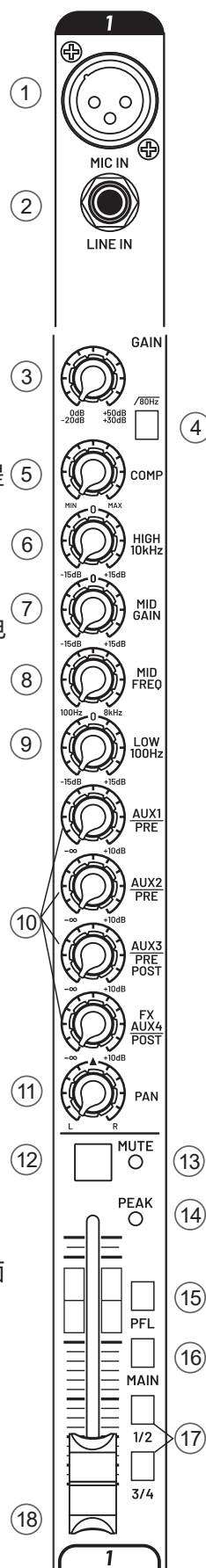

13 MUTE LED
这个静音按键配备了一个红色LED,当通道静音时,它会发光。

14 PEAK LED
该LED通常表示通道信号电平接近削波(失真),但在静音时也会亮起。峰值指示电路监测增益、EQ、主电平后的信号;因为峰值可能是由任何这些控件的高设置引起的。它以+15 dBu的静态信号(测试音)点亮,对应于高动态信号(即钢琴)的可听峰值。点亮时,应该降低增益和对EQ的提升,此时还大约剩余5dB的动态余量。输入增益和EQ的优化设置将导致此LED在最响亮的峰值处短暂闪烁。

15 PFL SWITCH
PFL按钮允许通过连接到CTRL ROOM OUTPUT的扬声器或通过连接到耳机输出来监听该通道上的信号。

16 MAIN SWITCH
位于推子右侧的主按钮允许信号分别路由到MAIN MIX。

17 GROUP 1-4 SWITCH
位于推子右侧的BUS 1/2, BUS3/4按钮允许信号分别路由到立体声总线1/2, 3/4。

18 CHANNEL FADER
通道推子,用来调节通道的信号水平,将信号输送到主输出,控制范围(-∞至+10dB,最佳位置为0dB)。

19 LINE/Hi-Z 开关
在不使用DI Box的情况下将吉他直接连接到调音台,请先按下此开关;然后将吉他的输出连接到通道的1/4" TRS输入。这样将对直接连接的输入阻抗和高频保真度得到保证。通道的1/4" TRS输入将变为线路输入,就像其他单声道线路输入一样。要在其他通道上使用吉他或其他乐器,您需要先使用外部DI盒。如果没有DI盒或者如果没有按下此开关吉他可能听起来沉闷和浑浊。

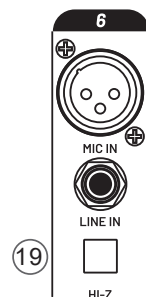

立体声输入通道

20 立体声输入 (RCA莲花口)
立体声线路输入设计为RCA L/R信号,它们可以接受来自mp3播放器或CD播放器的信号。

21 立体声输入
立体声线路输入设计用于1/4" TRS平衡或1/4" TS非平衡信号。如果您连接的是单声道源,请使用左(单声道)输入,单声道信号将出现在主混音的两侧。

22 立体声增益旋钮
该控制建立通道的标称操作电平,输入增益可以在很宽的范围内调整(-20至+30dB),为使信噪比最大化,应将增益设置为适当的电平,同时将通道推子置为0位,可以通过按下PFL开关并观察监听指示灯来设置增益,如果监听LED亮起并保持常亮,需降低增益。

23 线路输入和USB-B输入切换开关
当该开关为弹起状态时,该通道的输入信号将由线路提供。
当该开关为按下状态时,该通道的输入信号将由USB-B提供。

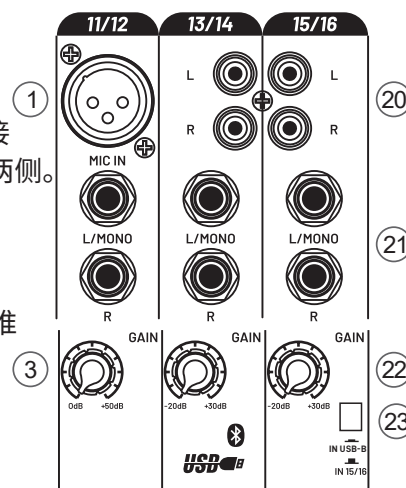

面板介绍

- 24 FX 脚踏开关
FOOT SWITCH 这个1/4"TRS连接器是接脚踏开关的地方，通过脚踏开关可以开启和关闭内部效果，如果内部效果通道已被静音，则脚踏开关工作无效。
- 25 耳机输出
这个1/4" TRS 连接器为立体声耳机提供输出。该通道输出音量通过PHONES音量控制旋钮控制。
- 26 左/右主输出
左/右输出具有2个1/4" TRS Z 平衡插孔和2个全平衡XLR 输出。1/4" 输出可与Tip, Ring, Sleeve (TRS) 平衡或Tip, Sleeve (TS) 非平衡连接器一起使用。输出电平由主电平推子(39) 设置。2个输出可同时使用。
- 27 控制室输出插孔
这些1/4" 插孔通常连接到控制室的输入放大器或耳机分配放大器。
- 28 幻象电源(XR-1824FX有2个)
该开关向输入XLR 连接器施加+48 VDC 电压，以为需要幻象电源的麦克风供电。如果使用幻象电源，请勿连接不平衡动态麦克风或其他无法处理此电压的XLR 输入设备。
- 29 效果路由到AUX1-3
此发送允许将FX 返回通道中的信号路由到AUX1-3 发送。
- 30 AUX3 推子前/推子后按键
此按钮允许选择AUX3/FX 位于推子前或推子后。
- 31 AUX1-4 MASTER
这些电位器控制辅助发送AUX1-4主电平。按下PFL按钮时，可以通过连接到CTRL ROOM OUTPUT 的扬声器(参见本手册的[27] 部分)或通过连接到PHONES OUTPUT 的耳机(参见第[25] 部分)收听单个辅助输出中存在的信号。
- 32 电平信号灯
这12 个LED 元件电平表允许控制主混音输出电平。将输出电平保持在“CLIP” 指示以下以避免信号过载这可能会导致失真。
- 33 PFL ACTIVE LED
当按下一个或多个PFL 按钮时，此LED 会亮起。
- 34 CTRL ROOM 音量旋钮
这是路由到CTRL ROOM 输出的信号电平控制。在此期间调音台正常使用时，主通道混音信号路由到此输出；当一个或按下更多PFL 按钮PFL 总线信号被路由到CTRLROOM输出和耳机输出。
- 35 耳机音量旋钮
该旋钮控制耳机输出的电平。设置耳机音量电平，请在连接和佩戴耳机之前控制到最小(-∞) 以避免听力失利。
- 36 监控部分
监听部分提供两个“TO CTRL ROOM” 按钮，上面按钮弹起状态监听主扩L/R路径的音频，按下则监听BUSSES路径的音频，下面按钮弹起状态监听BUS1/2路径的音频，按下则监听BUS3/4路径音频。

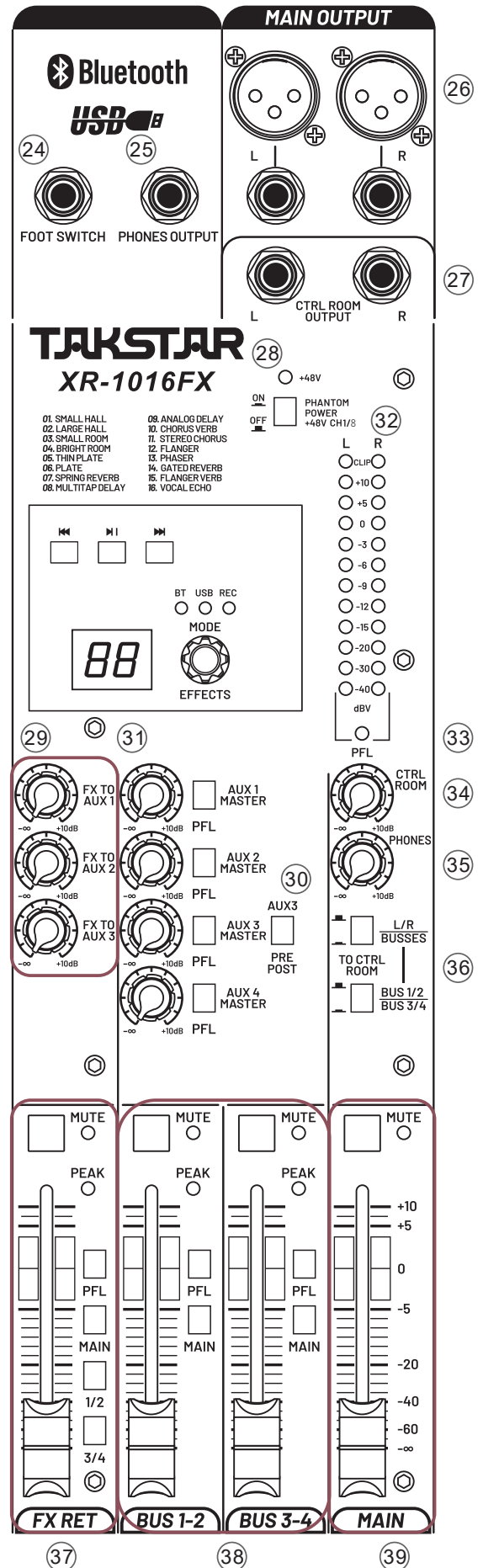

37 效果器推子
该推子控制来自内部DSP效果器的信号电平。静音按钮当按下时，禁止信号流向输出总线或主通道混音路径。PFL按钮允许当前通道的信号由CTRL ROOM和PHONES OUTPUT监听。MAIN按钮允许效果信号发送到主通道进行混音；1/2、3/4按钮允许效果信号发送到立体声总线BUS1/2和BUS3/4。

38 BUS 1/2, BUS 3/4 推子
推子BUS 1/2 和BUS 3/4 控制立体声总线输出的电平。BUS 1/2 和BUS 3/4 可以由每个输入通道馈送，以创建路由到物理BUS OUTPUTS的立体声音频组。按下MUTE 按钮时，会禁止信号流向BUS 输出或主混音路径。靠近BUS 推子的MAIN按钮将BUS 路由到MAIN MIX。按下PFL 按钮时，可以通过连接到CTRL ROOMOUTPUT的扬声器收听存在于BUS 中的信号或通过连接到PHONES OUTPUT的耳机监听。

39 主混音推子
MAIN MIX 推子控制MAIN MIX 的电平。

40 上一曲。

41 暂停/播放按键。

42 下一曲按键。

43 蓝牙播放 (BT) 模式指示灯。

44 U盘播放 (USB-A) 模式指示灯。

45 U盘录音 (REC) 模式指示灯。

46 编码器为(1-16)效果器选择旋钮及播放模式 (MODE) 选择按键。

47 数码管为(1-16)效果器状态显示。

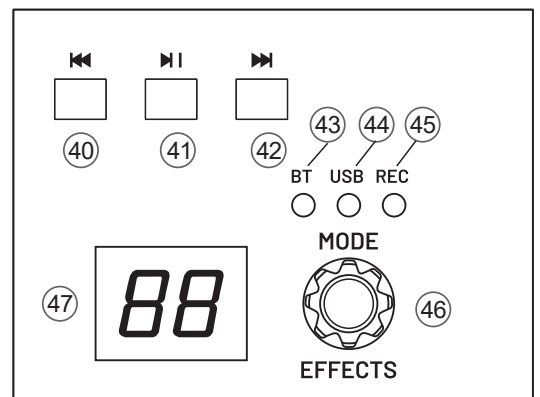
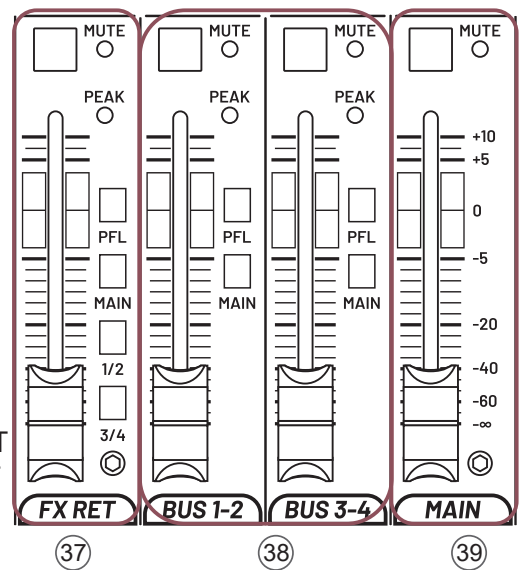

操作说明

a. BT 模式 (见右图)

开机上电后BT 指示灯将闪烁2分钟，此时在等待蓝牙连接状态，使用设备搜索Mixer BT，配对成功后，蓝牙灯将常亮，此时可以通过手动方式进行播放/暂停/上一曲/下一曲操作，用来播放设备的文件。如2分钟内，无蓝牙设备连接，则蓝牙灯自动熄灭，蓝牙处于关闭状态。如需再次连接设备，则需长按模式(MODE) 按键3秒，激活蓝牙进入等待连接状态，进行再次连接即可。

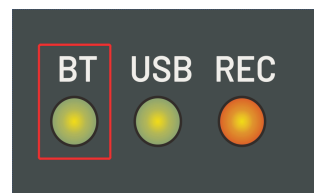

b. USB 模式 (见右图)

在USB-A插入U盘情况下，按模式(MODE)按键则可以切换到U盘播放模式，此时USB灯将点亮，可以通过手动方式进行播放/暂停/上一曲/下一曲操作，用来播放U盘上的音频文件。

注意：在USB-A未插入U盘情况下，按模式(MODE)按键无法切换到U盘播放模式。

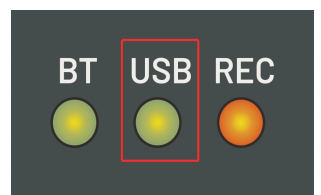

XR-1016FX/XR-1824FX 模拟调音台

c. REC 模式 (见右图)

在USB-A插入U盘且在U盘播放模式下（USB绿灯亮的情况下），长按模式(MODE)按键3秒，则进入录音模式，此时REC红灯为闪烁，表示正在录音，在录音的状态下，按动模式(MODE)按键3秒，则录音将暂停（等待状态下REC灯常亮红灯）。再次长按3秒模式(MODE)按键，则录音将继续进行（REC红灯为闪烁状态）。再次长按模式(MODE)键3秒，则退出录音模式，进入播放录音文件状态。

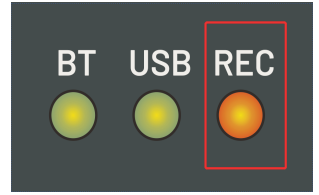

d. REC录音播放模式 (见右图)

在播放录音文件状态下，此时USB绿灯和REC红灯将同时在点亮状态，可以通过手动方式进行播放/暂停/上一曲/下一曲操作，用来播放当前U盘上已经录制好的音频文件。再次长按模式(MODE)键3秒继续录音，录音过程中长按3秒停止录音，再次按动模式(MODE)按键，则回到蓝牙模式，并继续循环操作及选择。

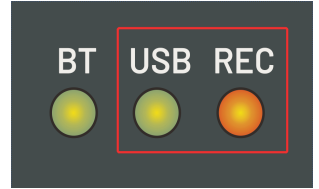

DSP效果器

XR-1016FX, XR-1824FX 配备内部 16 个预设 PRO DSP FX 板。旋转编码器允许在 16 种音效之间进行选择：

- | | | | |
|-----------------|--------------------|-------------------|--------------------|
| 01. SMALL HALL | 05. THIN PLATE | 09. ANALOG DELAY | 13. PHASER |
| 02. LARGE HALL | 06. PLATE | 10. CHORUS VERB | 14. GATED REVERB |
| 03. SMALL ROOM | 07. SPRING REVERB | 11. STEREO CHORUS | 15. FLANGER REVERB |
| 04. BRIGHT ROOM | 08. MULTITAP DELAY | 12. FLANGER | 16. VOCAL ECHO |

选择这些预设效果里面任何一种来丰富您的声音。

插头接线定义

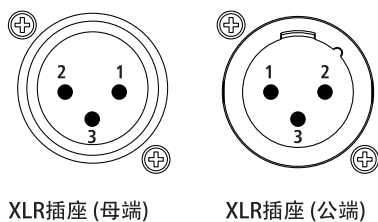
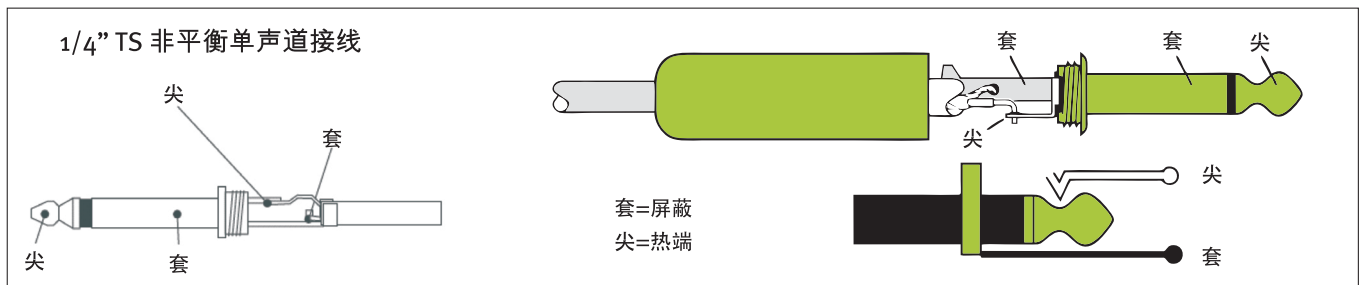
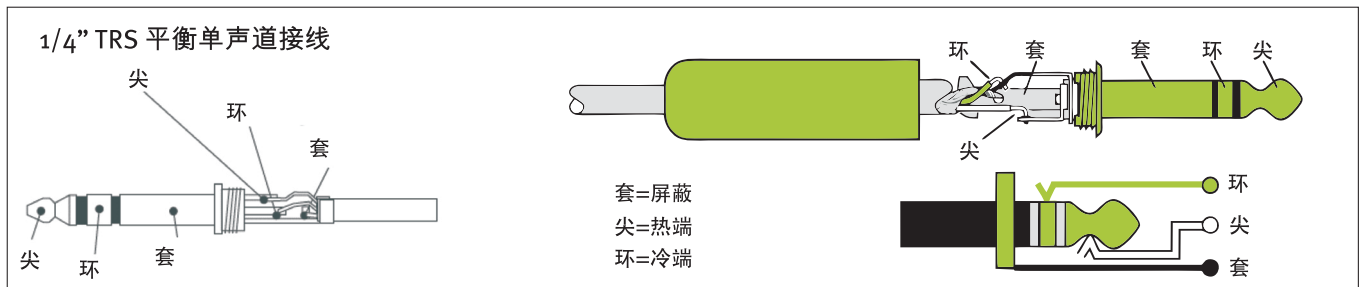

XLR插座

XLR 平衡头接线方法：
 1 = 屏蔽(地)
 2 = 正极(+ 或热端)
 3 = 负极(- 或冷端)

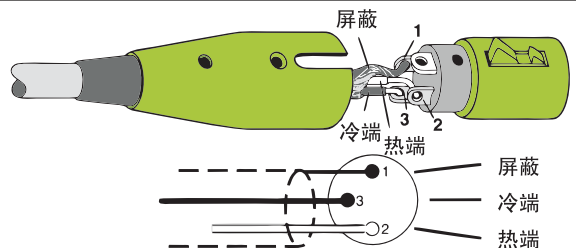

XR-1016FX方框图

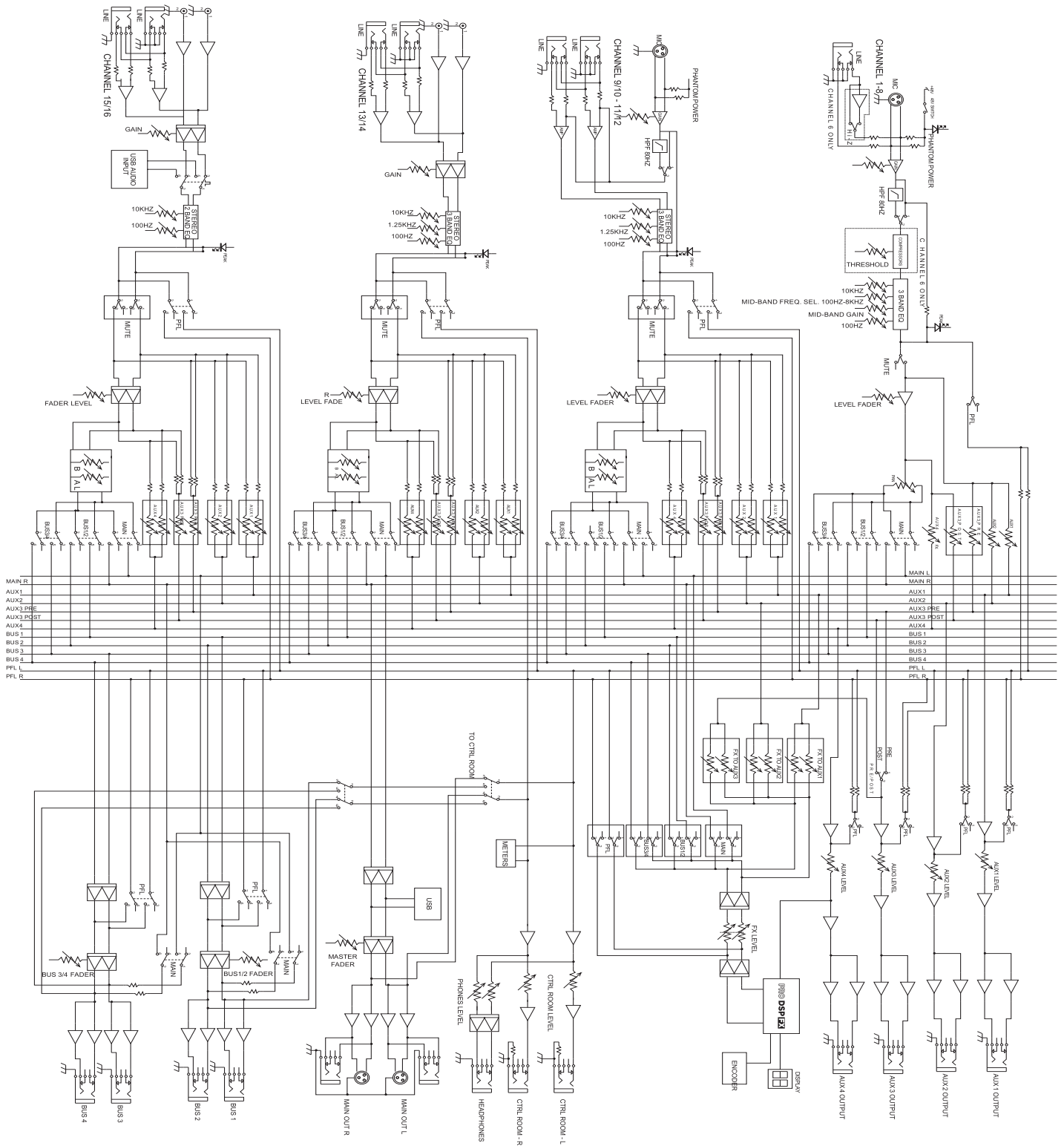

■ 安全警示

为避免电击、高温、着火、辐射、爆炸、机械危险以及使用不当等可能造成的人身伤害或财产损失，使用本产品前，请仔细阅读并遵守以下事项：

- 1.使用产品时请确认所连设备与本产品是否匹配以及合理调整音量大小，不要在超过产品功率及大音量下长时间使用，以免造成产品异常和听力损伤；
- 2.使用中若发现有异常（如冒烟、异味等），请立即关闭电源开关并拔掉电源插头，然后将产品送经销商检修；
- 3.本产品及配件都应放置在室内干燥通风处，请勿长期存放在潮湿、灰尘多的环境，使用中避免靠近火源、雨淋、进水、过度碰撞、抛掷、振动本机及覆盖通风孔，以免损坏其功能；
- 4.若产品需要固定于墙壁或天花板上时，请确保固定到位，防止因固定强度不足导致产品发生跌落危险；
- 5.使用该产品时需遵守相关安全规定，法律法规明确禁止使用场合请勿使用本产品，以免导致意外事故；
- 6.请不要自行拆机改装或维修，以防止出现人身伤害，如有问题或服务需求请联系当地经销商跟进处理。

注意事项：

1. 本单为保修凭证，请用户妥善保管，如有遗失，恕不保修或退换。
2. 保修期限限制：购买之日起十二个月内。
3. 除了不可抗力事件损坏外，由本公司负责，免费维修。
4. 如属保管不善或使用不当造成的损坏，维修点将酌情收费。
5. 擅自拆卸维修者，不予保修。
6. 以上保修条款仅限于中国市场适用（不包含港澳台地区）。

产品服务保证书

姓名：_____ 电话：_____ 地址：_____

商品：_____ 型号：_____ 购买日期：_____ 年__月__日

维修记录栏（由维修员填写）	维修员签名	日期

◆广东得胜电子有限公司 ◆电话：400-6828-333 ◆地址：广东省惠州市博罗县龙溪街道富康一路2号

XR-1824FX方框图

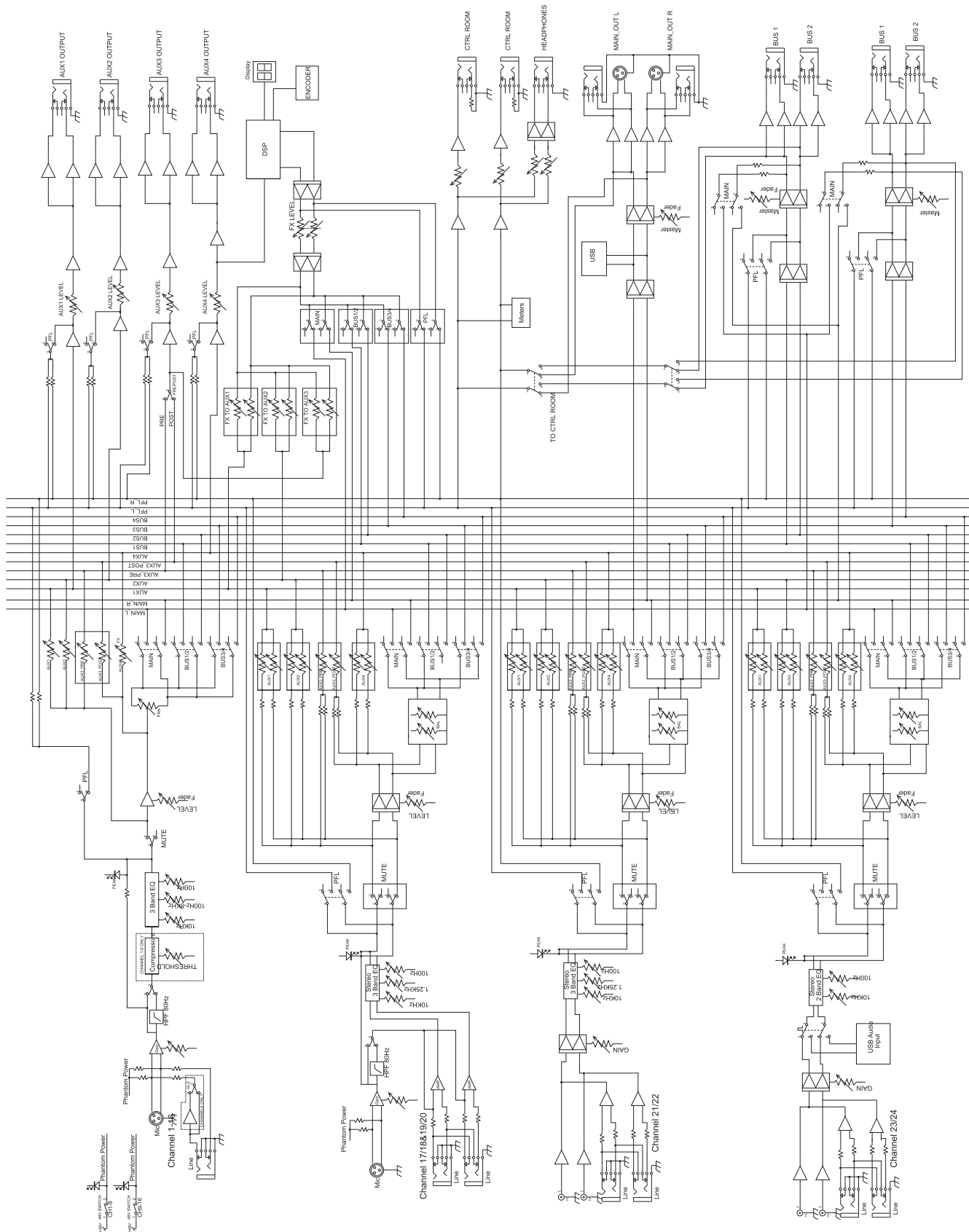

■ PREFACE

Dear Customer,

Thank you for purchasing Takstar XR-1016FX/XR-1824FX Analog Mixer. In order to better understand and use the product, please read this manual carefully.

If you have any questions or suggestions, please contact our local dealer.

■ FEATURES

- Robust metal housing
- Professional DSP effector with 16 effects available
- 8/16CH XLR mic inputs, 4CH bus outputs, 6CH with built-in compressor; separate stereo pan control on each channel
- Two stereo channels capable of direct routing to L/R
- Bluetooth & USB-A MP3 playback, stereo USB-B audio input & output
- Low-noise preamp + 48V phantom power
- 3-band equalizer on each channel for treble/mid-range/bass adjustment
- Studio quality headphone output
- 60mm high precision faders

■ APPLICATIONS

Commercial performances, large gatherings, outdoors

■ PACKING LIST

Analog Mixer.....	1
User Manual.....	1
Power Cord.....	1

■ SPECIFICATIONS

MONO INPUT

MIC IN: 8/16CH Bal XLR
Frequency Response: 20 Hz - 20 kHz, +/-1 dB
Distortion (THD+N): <0.003% at +0 dB, 20 Hz-20 kHz
Sensitivity: 0 dB to -50 dB
Max Input Level: +20 dBu
MIC IN Impedance: 14 k Ω , unbal
Phantom Power: +48V
Low Cut: 80 Hz

LINE IN: 8/16CH Bal TRS
Frequency Response: 20 Hz - 20 kHz, +/-1 dB
Distortion (THD+N): <0.003% at +0 dB, 20 Hz-20 kHz
Sensitivity: 20 dB to -30 dB
Max Input Level: +40 dBu
LINE IN Impedance: 21 k Ω , unbal

STEREO INPUT

LINE IN: 4 pairs of Bal TRS + 2 pairs of Unbal RCA
Frequency Response: 20 Hz - 20 kHz, +/-1 dB
Distortion (THD+N): <0.003% at +0 dB, 20 Hz-20 kHz
Sensitivity: 20 dB to -30 dB
LINE IN Impedance: 15 k Ω , unbal

MONO EQ

HIGH: +/-15 dB @ 10 kHz Shelving
MID: +/-15 dB @ Freq.sel. from 100Hz to 8kHz
-Bell
LOW: +/-15 dB @ 100 Hz Shelving

DSP

DSP: 20/27 bit digital signal
A/D & D/A Converter: 24 bit
FX Type: 4 algorithms: reverb, chorus, delay, flanger - 16 presets
Foot Switch: TS jack (for effect return mute and unmute)

STEREO EQ

HIGH: +/-15 dB @ 10 kHz Shelving
MID: +/-15 dB @ 1,250 kHz Bell
LOW: +/-15 dB @ 100 Hz Shelving

OUTPUT

MAIN OUTPUT: 1 pair of XLR + 1 pair of 6.3mm TRS
MAIN Max Output Level: +28 dBu
AUX OUTPUT: 4 TRS
AUX Max Output Level: +28 dBu
STEREO GROUP 1/2 OUTPUT: 2 TRS
GROUP Max Output Level: +28 dBu
STEREO GROUP 3/4 OUTPUT: 2 TRS
GROUP Max Output Level: +28 dBu
Monitor Output: 1 pair of TRS
Stereo Headphone Output: 1 Stereo TRS

POWER SUPPLY

Main Input Voltage: 100 V - 240 V AC, 50-60 Hz
Power Consumption: 30W

XR-1016FX Dimensions: 468*440*95 mm; Weight: 6.6 kg
XR-1824FX Dimensions: 680*450*95 mm; Weight: 9.3 kg

DESCRIPTIONS

XR-1016FX REAR PANEL

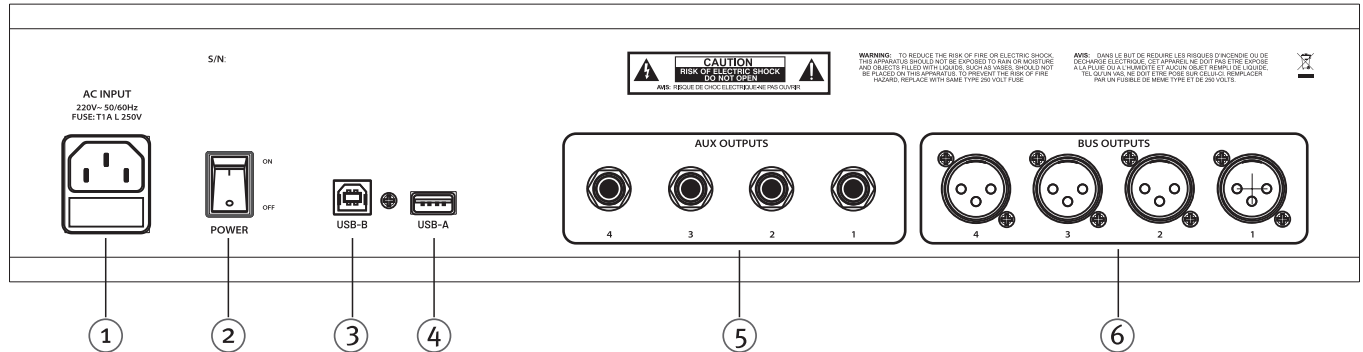

XR-1824FX REAR PANEL

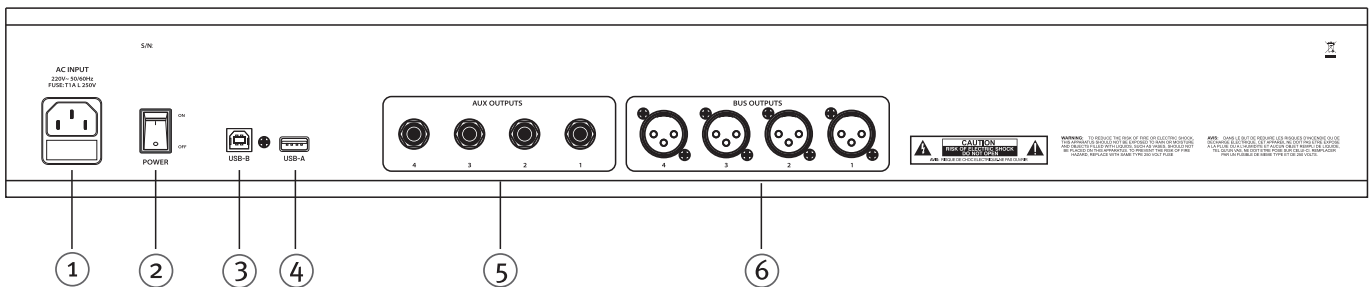

- ① **AC INPUT**
Connect the power cord to this socket and properly connect it to a 220V grounded AC power source.
- ② **POWER SWITCH**
Turns the mixer power on or off.
- ③ **USB-B CONNECTOR**
Connect a computer to this port via a UBS cable for stereo recording and playback of audio signals.
- ④ **USB-A STORAGE CONNECTOR**
Connect a USB flash drive for music playback and recording.
- ⑤ **AUX OUTPUTS 1 – 4**
These AUX outputs feature 1/4" TRS balanced jacks and provide signal from auxiliary outputs. The output level is controlled by the AUX Level control (10).
- ⑥ **BUS OUTPUTS 1 – 4**
These BUS outputs feature 1/4" TRS balanced jacks and provide signal from group outputs. The output level is controlled by the BUS Level fader.

MONO INPUT

- 1 MIC IN
This XLR balanced mic preamp input supports sources with a gain range of 0 dB to -50 dB. All MIC/LINE inputs feature an 80 Hz high pass filter, which can be enabled to reduce low frequency pops, bumping and rattling noise when using a mic for vocals.
- 2 LINE IN (1/4)
These jacks are 1/4" balanced (TRS) high impedance inputs. The cores are positive and used for unbalanced inputs. MIC IN and LINE IN should not be used at the same time.
- 3 GAIN
May refer to MIC GAIN or LINE GAIN subject to input source. Using MIC IN, Gain Range: 0~50dB; Using LINE IN, Gain Range: -20~+30dB. Preferably set to a level where PEAK LED only flashes occasionally, so to prevent distortion.
- 4 LOW CUT
An 80Hz low cut filter toggle. Enable it to cut off unwanted low frequency noise (e.g., operating noise, stage noise, air noise) to improve clarity. These unwanted energy could drain power from your audio system.
- 5 COMP
Turning this knob clockwise lowers the compressor threshold, increasing the amount of compression. The compression ratio is within 4:1 and varies with the signal level and the amount of compression. This is useful for controlling peak levels from live sources, and is designed to subtly tame the level of live vocals without noticeable artifacts.
- 6 HIGH EQ
This smooth-tilt tone control adjusts treble frequency levels (± 15 dB at 10 kHz), reducing noise or boosting brightness.
- 7 MID EQ
The IF control is set to 1250 Hz, with a gain of +/-15 dB and a bell curve.
- 8 MID FREQ
This control knob determines the center frequency of the MID EQ control. The center frequency of the bandpass filter can be set between 100 Hz and 8kHz.
- 9 LOW EQ
This smooth-tilt tone control adjusts the bass frequency level (± 15 dB at 100 Hz), adding depth to thin sounds or clarity to overly thick sounds.
- 10 AUX1-4
Each channel of the XR-1016FX mixer provides 4 aux sends; AUX1 and AUX2 are PRE fader sends. AUX3 is a POST or PRE fader send, depending on the position of the AUX3 PRE/POST button (32). FX/AUX4 send is always post-fader. FX/AUX4 is sent to the internal PRO DSP FX board. Signals in FX/AUX4 send are also routed to the AUX4 OUTPUT jack on the rear panel.
- 11 PAN
This control determines the signal position of the assigned L/R channel and group 1/2 bus. Turning the knob counterclockwise increases the amount of signal sent to the left channel and odd group; while turning it clockwise increases the amount of signal sent to the right channel and even group.
For example, when the GROUP SWITCH (17) is in the 1/2 position, turning the knob counter-clockwise will increase the amount of signal sent to Group 1, and turning it clockwise will increase the amount sent to Group 2. Equal amount is sent to each group if rotated to the middle.

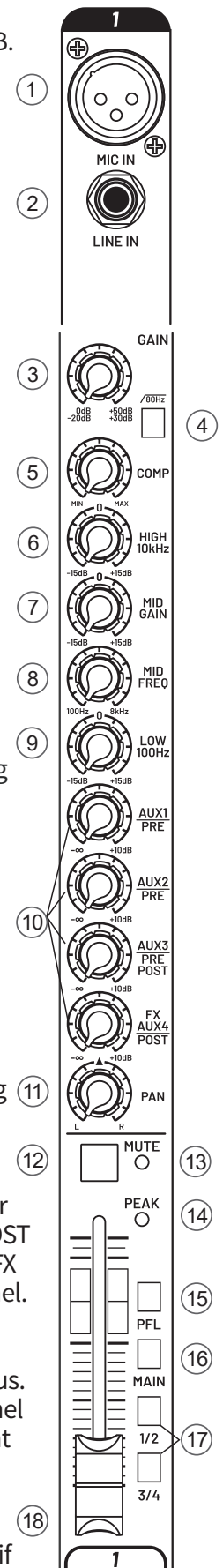

XR-1016FX/XR-1824FX ANALOG MIXER

12 MUTE SWITCH

Pressing this switch will mute the signal sent to the main mix, aux sends, and FX effects. The mute switch does not affect the signal sent to the solo system.

13 MUTE LED

The mute button is equipped with a red LED that lights up when the channel is muted.

14 PEAK LED

This LED usually indicates that the channel signal level is approaching clipping (distortion), but it also lights up when muted. Because the peak indicator circuit monitors the signal after gain, EQ and master level, peaks can be caused by high settings of any of these controls. It lights up upon a static signal (test sound) of +15 dBu, which corresponds to the audible peak of a highly dynamic signal (i.e. a piano). When lit, there is about 5dB of headroom remaining, and the gain and EQ boost should be reduced. Under optimal settings of input gain and EQ, LED will only flash briefly at the loudest peak.

15 PFL SWITCH

This PFL button allows monitoring of the signal on this channel through a speaker connected to the CTRL ROOM OUTPUT or a headphone connected to the PHONES OUTPUT.

16 MAIN SWITCH

This button allows signals to be routed individually to the MAIN MIX.

17 GROUP 1-4 SWITCH

The BUS1/2, BUS3/4 buttons allow the signal to be routed to the stereo BUS 1/2, 3/4 respectively.

18 CHANNEL FADER

Used to adjust the signal level of the channel sent to the main output; control range is $-\infty$ to +10dB, the optimal position is 0dB.

19 LINE/Hi-Z SWITCH

To connect a guitar directly to the mixer without using a DI Box, press this switch down first; then connect the guitar's output to the channel's 1/4" TRS input. This helps to match the directly connected input impedance and preserve high frequency fidelity. The channel's 1/4" TRS input will become a line input, just like any other mono line input. To use guitars or other instruments on other channels, you'll need to use an external DI box first. Without the DI box or if this switch is not pressed the guitar may sound dull and muddy.

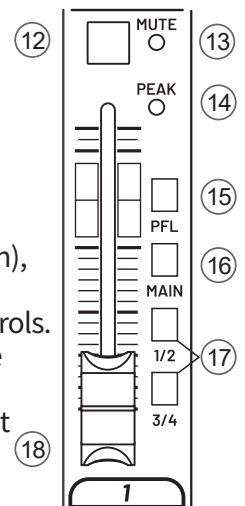

STEREO INPUT

20 STEREO INPUTS (RCA)

RCA L/R line input which accepts signal from MP3 or CD player.

21 STEREO INPUTS

1/4" TRS balanced or 1/4" TS unbalanced line inputs. If you are connecting a mono source, use the left (mono) input and the mono signal will appear on both sides of the main mix.

22 STEREO GAIN

This control establishes the nominal operating level of the channel. The input gain can be adjusted in a wide range (-20—+30dB). To maximize the signal-to-noise ratio, the gain should be set to an appropriate level. To do so, set the channel fader to 0, then press the PFL switch and observe the LEVEL LED. If the CLIP LED glows and stays red, you need to reduce the gain.

23 LINE IN / USB-B IN SWITCH

When this switch is not pressed, the input signal of this channel is provided by line input; or when pressed, provided by USB-B.

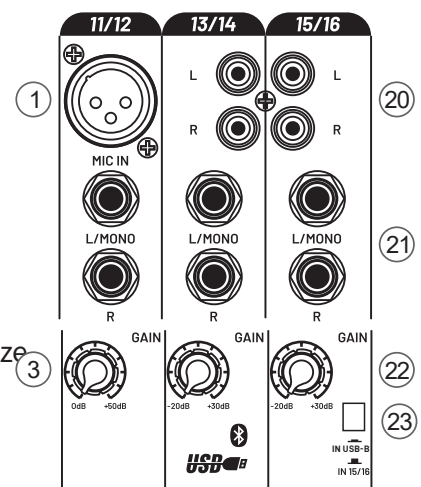

PANEL

- 24 FOOT SWITCH
This 1/4" TRS connector is where the foot switch is connected. The internal effect can be turned on and off through the foot switch. If the internal effect channel has been muted, the foot switch will not work.
- 25 PHONES OUTPUT
This 1/4" TRS connector provides stereo headphone output. The output volume of this channel is controlled by the PHONES volume control knob.
- 26 L/R MAIN OUTPUT
There are two 1/4" TRS balanced jacks and two balanced XLR outputs for Left/Right outputs. 1/4" output can be connected with Tip, Ring, Sleeve (TRS) balanced or Tip, Sleeve (TS) unbalanced connector. Its output level is controlled by MAIN FADER (39). Both XLR and TRS outputs can be used at the same time.
- 27 CTRL ROOM OUTPUT
These 1/4" jacks are usually connected to the input amplifier or headphone amplifier in the control room.
- 28 PHANTOM POWER (two on XR-1824FX)
This switch applies +48VDC to the XLR input connector to power mics that require phantom power. If enabled, do not connect unbalanced dynamic mics or other XLR input devices that cannot handle this voltage.
- 29 FX TO AUX 1-3
This allows routing of signal in the FX return channel to AUX1-3 send.
- 30 AUX3 PRE/POST
This button sets whether the AUX3/FX signal is pre-fader or post-fader.
- 31 AUX 1-4 MASTER
These potentiometers control the AUX1-4 master level. When PFL button is pressed, the signal present on the respective individual aux output can be monitored through the speaker connected to the CTRL ROOM OUTPUT (27) or the headphones connected to the PHONES OUTPUT (25).
- 32 LEVEL LED
This 12-LED level meter helps to control the main mix output level. Keep the output level below the "CLIP" LED to avoid signal overload and distortion.
- 33 PFL ACTIVE LED
This LED illuminates when one or more of the PFL buttons are pressed.
- 34 CTRL ROOM VOLUME
This is the level control of signal routed to the CTRL ROOM OUTPUT. During regular use, the main channel mix signal is routed to this output; when one or more PFL buttons are pressed, the PFL bus signal is routed to CTRL ROOM OUTPUT and PHONES OUTPUT.
- 35 PHONES VOLUME
This knob controls the level of the headphone output. Set the headphone volume level to the minimum (-∞) before connecting and wearing headphones to avoid hearing damage.

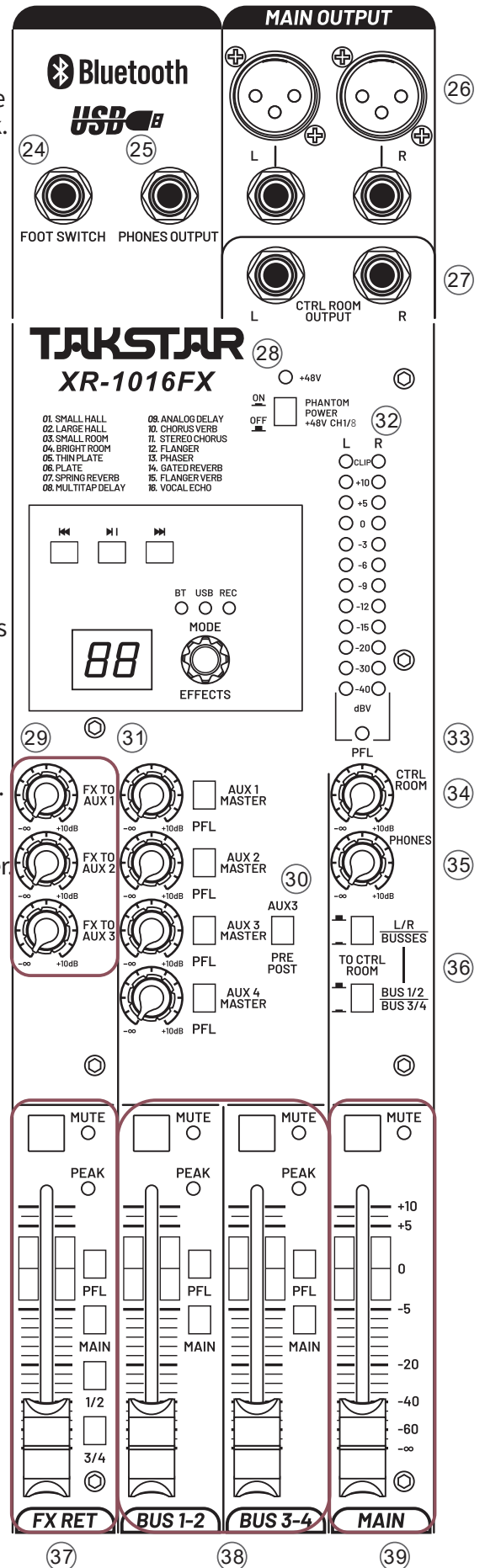

36 MONITOR SETTINGS
 There are two buttons for monitoring settings. For the upper button: when not pressed, it monitors the audio from MAIN L/R; when pressed, it monitors audio from BUSSES. For the lower button: when not pressed, it monitors audio from BUS 1/2; when pressed, it monitors audio from BUS 3/4.

37 FX FADER
 This fader controls the signal level from the internal DSP effector. The mute button, when pressed, disables signal flow to the output bus or main mix. The PFL button allows the current channel's signal to be monitored by CTRL ROOM OUTPUT and PHONES OUTPUT. The MAIN button allows the effect signal to be sent to the main channel for mixing. The 1/2, 3/4 buttons allow the effect signal to be sent to the stereo busses BUS 1/2 or BUS 3/4.

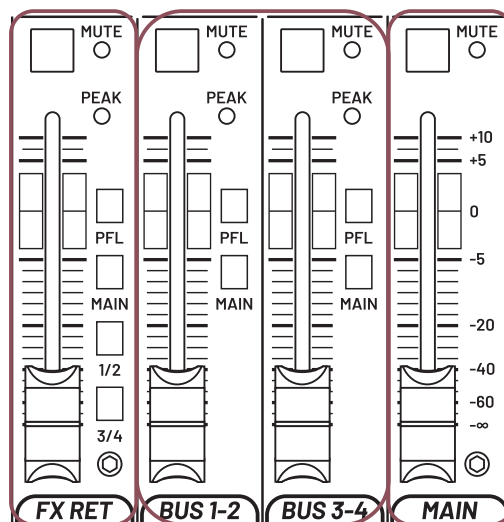

38 BUS 1/2, BUS 3/4 FADER
 Faders BUS1/2 and BUS3/4 control the level of the stereo bus outputs. BUS 1/2 and BUS 3/4 can be fed by each input channel to create stereo audio groups routed to the physical BUS OUTPUTS. When the MUTE button is pressed, signal flow to the BUS output or main mix is disabled. The MAIN button next to the BUS fader routes the BUS to the MAIN MIX. When the PFL button is pressed, the signal present in the BUS can be monitored through speaker connected to CTRL ROOM OUTPUT or headphones connected to PHONES OUTPUT.

39 MAIN FADER
 This fader controls the level of the MAIN MIX.

40 PREVIOUS TRACK

41 PAUSE/PLAY

42 NEXT TRACK

43 BLUETOOTH (BT) MODE LED

44 USB-A PLAYBACK MODE LED

45 USB REC MODE LED

46 EFFECTS SELECTION (1-16) KNOB & MODE SELECTION BUTTON

47 EFFECT STATUS (1-16) DISPLAY

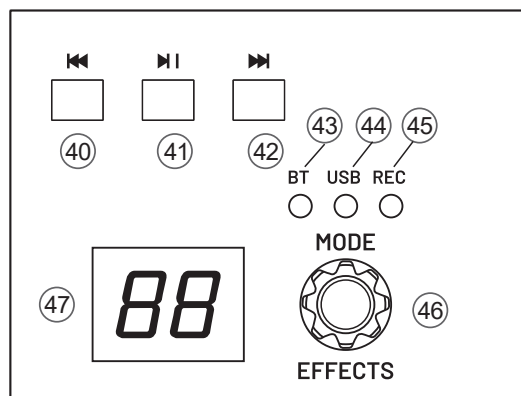

OPERATIONS

a. BT MODE (see picture on the right)

After power on, the BT indicator will flash for 2 minutes, awaiting Bluetooth connection. Search for "Mixer BT" on your Bluetooth device and connect. Once paired successful, the BT indicator will stay lit. You can then manually play media inside your device using PAUSE/PLAY/PREVIOUS TRACK/NEXT TRACK. If without Bluetooth connection within 2 minutes, the Bluetooth function automatically shuts down and the BT indicator turns off. To re-try Bluetooth connection, press and hold the MODE button for 3 seconds to activate Bluetooth pairing and establish connection.

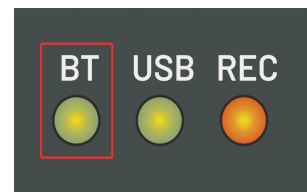

b. USB MODE (see picture on the right)

When a USB drive is inserted via USB-A port, press the MODE button to switch to USB playback mode. In this case, the USB indicator will light up, and you can play media inside your USB drive using PAUSE/PLAY/PREVIOUS TRACK/NEXT TRACK. Note: You cannot switch to USB playback mode by pressing the MODE button if no USB drive is inserted via USB-A.

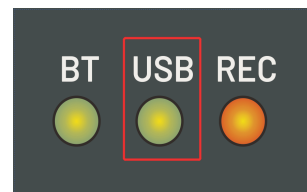

XR-1016FX/XR-1824FX ANALOG MIXER

c. REC MODE (see picture on the right)

While a USB drive is inserted via USB-A and mixer under USB playback mode (i.e., green USB indicator glows), press and hold MODE button for 3 seconds to enter REC mode. In this case, the REC indicator flashes red while recording normally. Press and hold MODE button for 3 seconds again to pause recording (REC indicator glows solid red). Again, press and hold MODE button for 3 seconds to exit REC mode and start playback of the recorded file.

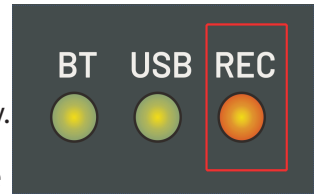

d. REC PLAYBACK MODE (see picture on the right)

While playing the recording file, the USB green light and the REC red light will be on at the same time, and you can control the playback using PAUSE/PLAY/PREVIOUS TRACK/NEXT TRACK audio file. Press and hold the MODE button again for 3 seconds to continue recording. During the recording process, press and hold the MODE button for 3 seconds to pause recording. While paused, press the MODE button once to return to Bluetooth mode, and start new operation or selection.

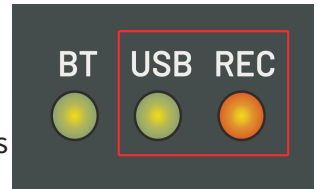

DSP Effector

Both XR-1016FX and XR-1824FX are equipped with an internal PRO DSP FX board with 16 FX presets. Rotate the EFFECTS KNOB to select among the 16 sound effects:

- | | | | |
|-----------------|--------------------|-------------------|--------------------|
| 01. SMALL HALL | 05. THIN PLATE | 09. ANALOG DELAY | 13. PHASER |
| 02. LARGE HALL | 06. PLATE | 10. CHORUS VERB | 14. GATED REVERB |
| 03. SMALL ROOM | 07. SPRING REVERB | 11. STEREO CHORUS | 15. FLANGER REVERB |
| 04. BRIGHT ROOM | 08. MULTITAP DELAY | 12. FLANGER | 16. VOCAL ECHO |

Enrich your audio with any of the above preset effects.

PLUG PINOUT DIAGRAM

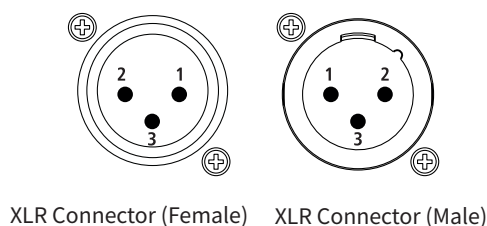
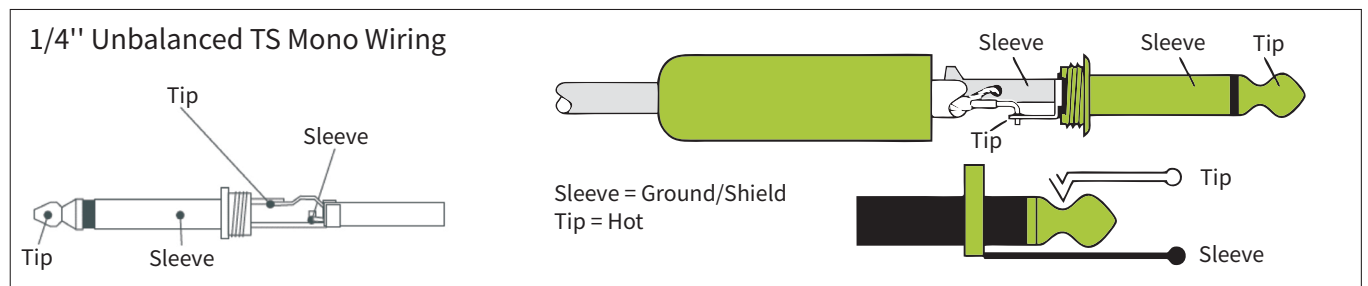
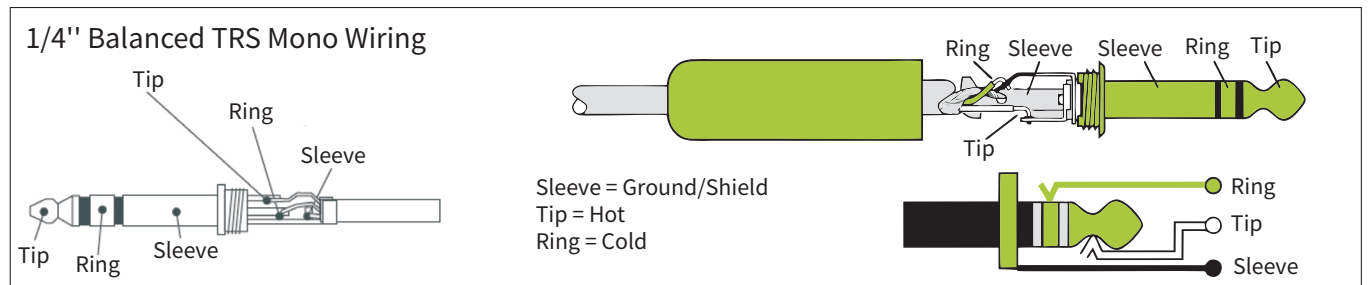

XLR Connector

- Bal XLR Wiring:
 1 = Shield (Ground)
 2 = Positive (+/Hot)
 3 = Negative (-/Cold)

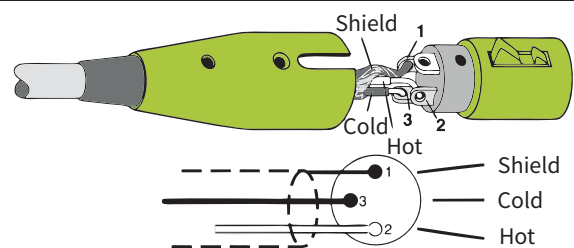

XR-1016FX BLOCK DIAGRAM

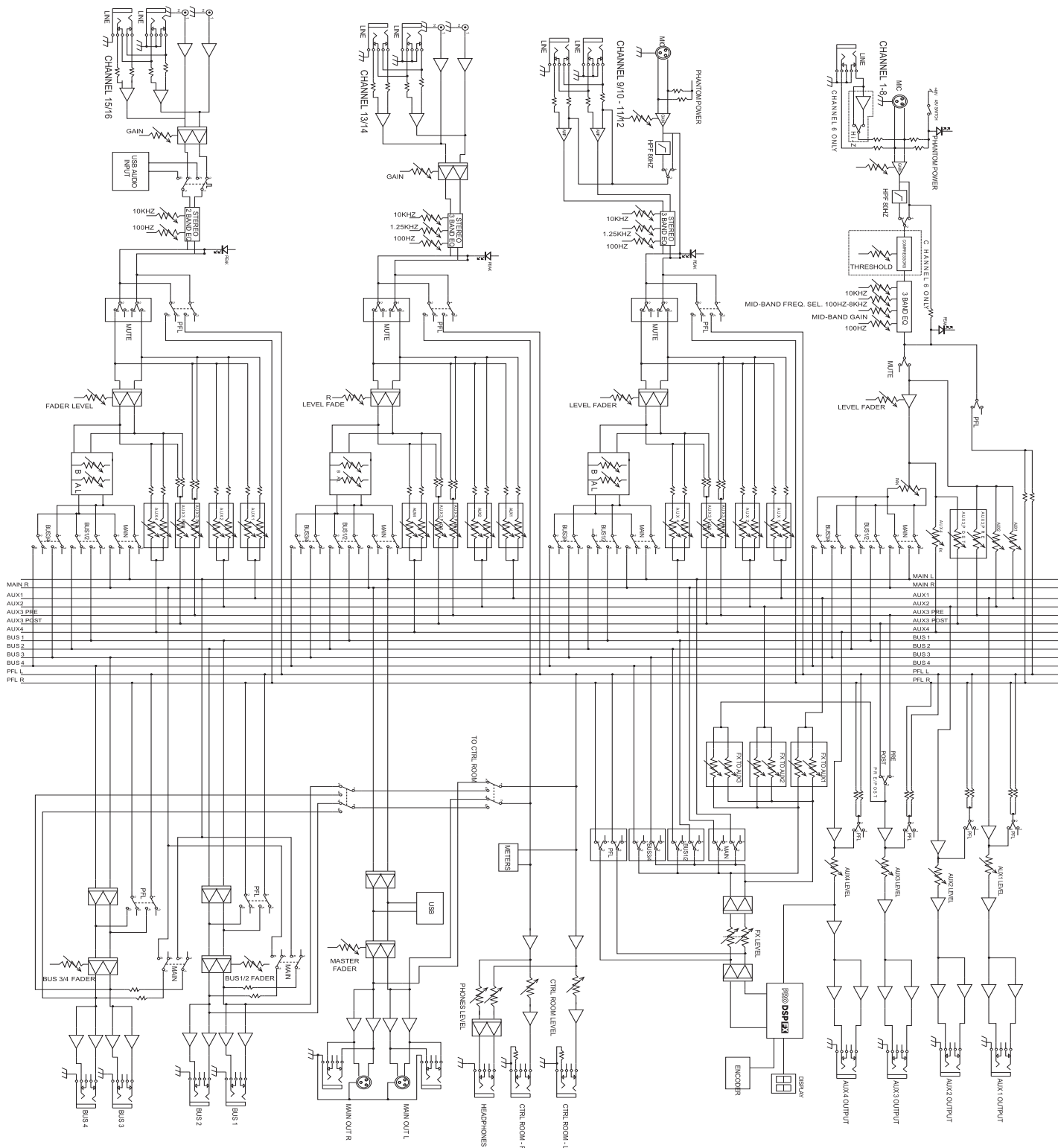

XR-1824FX BLOCK DIAGRAM

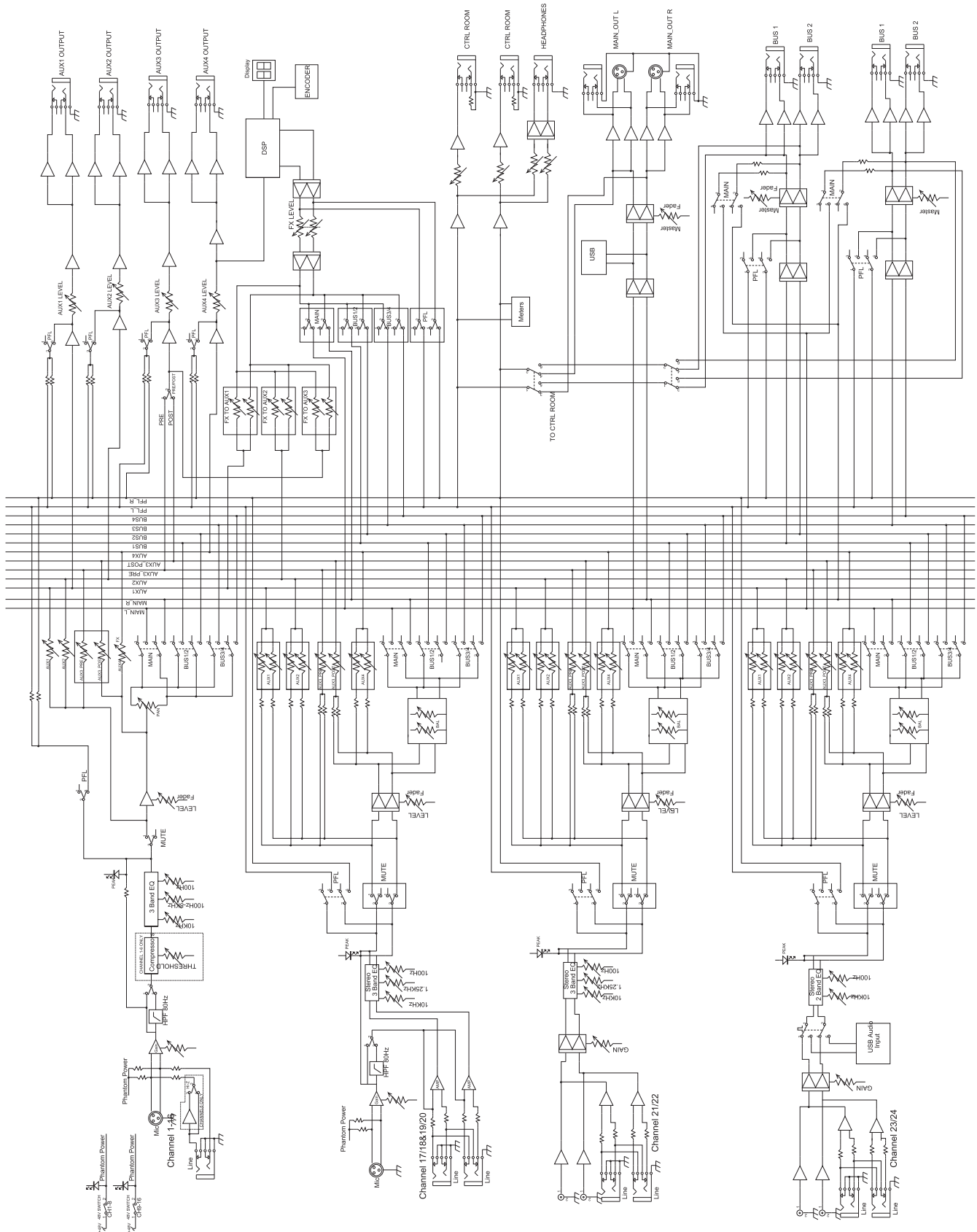

■ CAUTIONS

To avoid electric shock, overheat, fire, radiation, explosion, mechanical risk and injury or property loss due to improper use, please read and observe the following items before use:

1. Please check if the power of the connected equipment matches with that of this product before operation. Adjust the volume to proper level during operation. Do not operate at over-power or high-volume level for extended time to avoid product malfunction or hearing impairment.
2. If there is any abnormality during use (e.g., smoke, strange odor), please kill the power switch and unplug from power source, then send the product to the dealer for repair.
3. Keep this product and its accessories in a dry and ventilated area. Do not store in a humid or dusty area for extended time. Keep away from fire, rain, liquid intrusion, bumping, throwing, vibrating, or from blocking any ventilation openings, to prevent malfunction.
4. The product must, when installed on walls or ceilings, be fixed firmly in place at adequate strength to prevent from falling.
5. Please abide by safety rules during operation. Do not use the product in places prohibited by laws or regulations to avoid accident.
6. Do not disassemble or repair the product by yourself to avoid injury. If you have any questions or require any services, please contact our local dealer.



扫一扫，了解更多产品
Scan for more
product information

广东省电声工程技术研究开发中心 广东得胜电子有限公司制造

地址：广东省惠州市博罗县龙溪街道富康一路2号

服务热线：400 6828 333 传真：0752 6383950

邮箱：xs@takstar.com

网址：www.takstar.com

Guangdong Takstar Electronic Co., Ltd.

Address: No. 2 Fu Kang Yi Rd., Longxi Boluo

Huizhou, Guangdong 516121 China

Tel: 86 752 6383644 Fax: 86 752 6383952

Email: sales@takstar.com

Website: www.takstar.com